

GENERAC®
Portable Products

2300PSI

High Pressure Washer Owner's Manual

**Problems?
Questions?**
Before taking your unit
back to the store,
call the pressure washer
helpline at
1-800-270-1408
M-F 8-5 CT

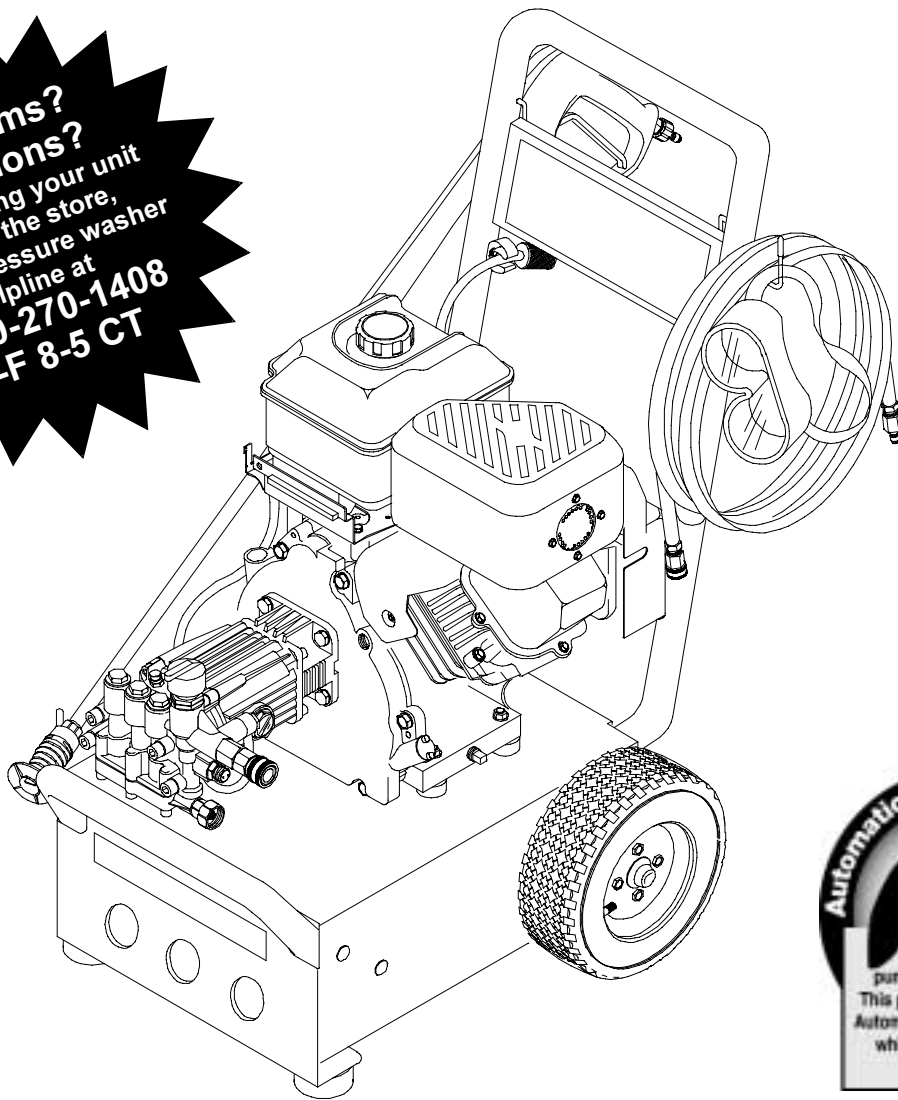

Model No. 1292-2 (2300 PSI High Pressure Washer) Manual No. B5715 Revision 2 (8/3/2000)

Visit our Generac website: www.generac-portables.com



This is the safety alert symbol. It is used to alert you to potential personal injury hazards. Obey all safety messages that follow this symbol to avoid possible injury or death.



EQUIPMENT DESCRIPTION

CONGRATULATIONS on your purchase of a GENERAC high pressure washer. It has been designed, engineered and manufactured to give you the best possible dependability and performance.

This manual contains information for a high pressure washer that operates at 2,300 PSI at a flow rate of 2.9 gallons per minute. This high quality residential system features large 10" wheels, pump equipped with an automatic cool down system, chemical injection system, adjustable spray nozzle. Includes safety goggles, heavy duty 25' hose, and more.

Please read and retain this manual. The instructions will enable you to assemble your unit, and maintain your high pressure washer properly.

Every effort has been made to ensure that the information in this manual is both accurate and current. However, Generac reserves the right to change, alter or otherwise improve the product and its documentation at any time without prior notice.

Should you experience any problem you cannot easily fix, call the pressure washer helpline at **1-800-270-1408**.

CUSTOMER RESPONSIBILITIES

- Read and observe the safety rules.
- Follow regular schedule in maintaining, caring for and using your high pressure washer.
- For off-season storage, review "Preparing The Unit For Storage" on page 13.

SAFETY RULES

 **CAUTION!** When setting up, transporting, adjusting or making repairs to your high pressure washer, always disconnect the spark plug wire from the spark plug and place the wire where it cannot contact spark plug.

 **DANGER!** Engine exhaust gases contain DEADLY carbon monoxide gas. This dangerous gas, if breathed in sufficient concentrations, can cause unconsciousness or even death. Operate this equipment only in the open air where adequate ventilation is available.

 **DANGER!** Gasoline is highly FLAMMABLE and its vapors are EXPLOSIVE. **Do Not** permit smoking, open flames, sparks or heat in the vicinity while handling gasoline. Avoid spilling gasoline on a hot engine. Allow unit to cool for 2 minutes before refueling. Comply with all laws regulating storage and handling of gasoline.

Read this manual carefully and become familiar with your pressure washer. Know its applications, its limitations, and any hazards involved.



WARNING:



The engine exhaust from this product contains chemicals known to the State of California to cause cancer, birth defects, or other reproductive harm.

- Locate this pressure washer in areas away from combustible materials, combustible fumes or dust.
- The high pressure equipment is designed to be used with Generac authorized parts only. If you use this equipment with parts that do not comply with minimum specifications, the user assumes all risks and liabilities.
- Some chemicals or detergents may be harmful if inhaled or ingested, causing severe nausea, fainting or poisoning. The harmful elements may cause property damage or severe injury.
- **Do Not** allow CHILDREN to operate the pressure washer at any time.



- Operate engine only at governed speed. Running the engine at excessive speeds increases the hazard of personal injury. **Do Not** tamper with parts which may change the governed speed.
 - **Do Not** wear loose clothing, jewelry or anything that may be caught in the starter or other rotating parts.
 - Before starting the pressure washer in cold weather, check all parts of the equipment and be sure ice has not formed there.
 - **Never** use a spray gun which does not have a trigger lock or trigger guard in place and in working order.
 - Keep the hose connected to machine or the spray gun while the system is pressurized. Disconnecting the hose while the unit is pressurized is dangerous.
 - Units with broken or missing parts, or without protective housing or covers, should **Never** be operated.
 - Check the fuel system for leaks or signs of deterioration, such as chafed or spongy hose, loose or missing clamps, or damaged tank or cap. Correct all defects before operating the pressure washer.
 - **Do Not** spray flammable liquids.
 - Use a respirator or mask whenever there is a chance that vapors may be inhaled. Read all instructions with mask so you are certain the mask will provide the necessary protection against inhaling harmful vapors.
 - **Never** aim the spray gun at people, animals or plants. The high pressure stream of water that this equipment produces can pierce skin and its underlying tissues, leading to serious injury and possible amputation.
 - **Never** allow any part of the body to come in contact with the fluid stream. **Do Not** come in contact with a fluid stream created by a leak in the high pressure hose.
 - Always wear eye protection when you use this equipment or when you are in the vicinity where the equipment is in use.
 - High pressure spray can cause paint chips or other particles to become airborne.
 - **Do Not** operate the pressure washer above the rated pressure.
 - **Never** move the machine by pulling on the high pressure hose. Use the handle provided on the unit.
 - Always be certain the spray gun, nozzles and accessories are correctly attached.
 - **Do Not** secure the spray gun in the (open) position.
 - High pressure spray may damage fragile items including glass. **Do Not** point spray gun at glass when in the jet spray mode.
 - Hold the spray gun firmly in your hand before you start the unit. Failure to do so could result in an injury from a whipping spray gun. **Do Not** leave the spray gun unattended while the machine is running.
 - The cleaning area should have adequate slopes and drainage to reduce the possibility of a fall due to slippery surfaces.
 - Operate and store this unit on a stable surface.
 - Keep water spray away from electric wiring or fatal electric shock may result.
 - **Do Not** by-pass any safety device on this machine.
 - The muffler and engine heat up during operation and remain hot immediately after shutting it down. Avoid contact with a hot muffler or engine as you could be severely burned.
 - High pressure hose can develop leaks from wear, kinking, abuse, etc. Water spraying from a leak is capable of injecting material into skin. Inspect hose each time before using it. Check all hoses for cuts, leaks, abrasions or bulging of cover, or damage or movement of couplings. If any of these conditions exist, replace hose immediately. **Never** repair high pressure hose. Replace it with another hose that exceeds the maximum pressure rating of your unit.
 - The muffler and air cleaner must be installed and in good condition before operating the pressure washer. These components act as spark arresters if the engine backfires.
- In the State of California a spark arrester is required by law (Section 4442 of the California Public Resources Code). Other states may have similar laws. Federal laws apply on federal lands.
- NOTE:** If you equip the muffler with a spark arrester, it must be maintained in effective working order. You can order a spark arrester through your authorized Briggs and Stratton service dealer.



KNOW YOUR PRESSURE WASHER

Read this owner's manual and safety rules before operating your high pressure washer.

Compare the illustrations with your high pressure washer to familiarize yourself with the locations of various controls and adjustments. Save this manual for future reference.

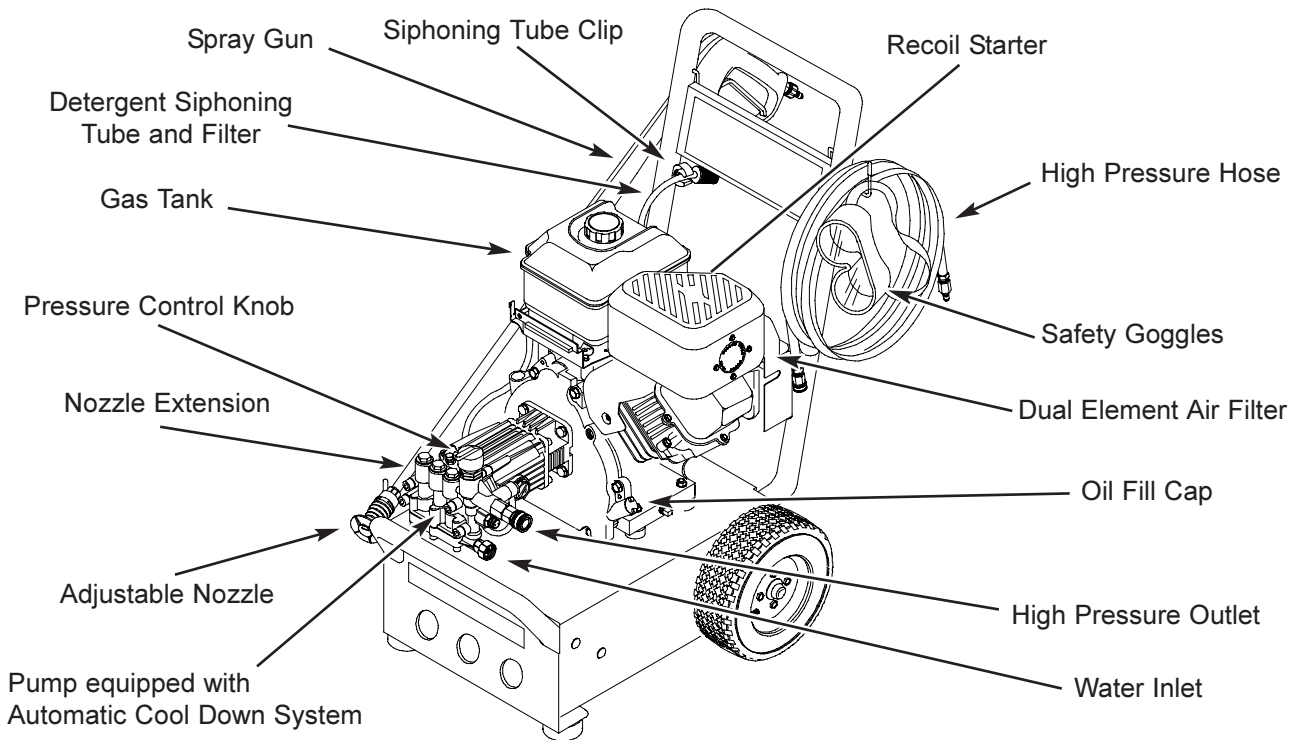

Adjustable Nozzle — Always attached to nozzle extension. Pull back for high pressure or push forward for low pressure. Turn clockwise for narrow spray, turn counterclockwise for fan spray.

Detergent Siphoning Tube and Filter — Used to siphon detergent from the chemical bottle into the low pressure water stream.

Dual Element Air Filter — Filter limits the amount of dirt and dust that gets in the engine.

Gas Tank — Fill tank with regular unleaded gasoline.

High Pressure Hose — Connect one end to the water pump and the other end to the spray gun.

High Pressure Outlet — Connection for high pressure hose.

Nozzle Extension — Attach to spray gun to use adjustable nozzle.

Oil Fill Cap — Fill engine with oil here.

Pressure Control Knob — Varies the pressure of the high pressure spray.

Pump — Develops high water pressure.

Recoil Starter — Use for starting the engine manually.

Safety Goggles — Always use the supplied goggles or other eye protection when running your pressure washer.

Siphoning Tube Clip — Used to hold the siphoning tube when the siphoning tube is not being used.

Spray Gun — Controls the application of water onto cleaning surface with trigger device. Includes safety latch.

Water Inlet — Connect garden hose here.

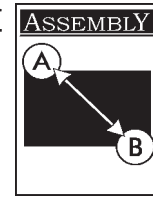

WARNING! Read entire owner's manual before you attempt to assemble or operate your new pressure washer.

REMOVE PRESSURE WASHER FROM CARTON

- Remove the high pressure hose and parts box included with pressure washer.
- Slice two corners at the end of carton from top to bottom so the panel can be folded down flat, then remove all packing material.
- Roll pressure washer out of carton.

Carton Contents

Items in the carton include:

- Main Unit
- Parts Box (which includes the following):
 - High Pressure Hose
 - Wireform
 - Goggles
 - Nozzle Cleaning Kit
 - Owner's Manual
 - Engine Manual
 - Owner's Registration Card
 - Handle
 - 2 Carriage Bolts
 - 2 Knobs
 - Siphoning Tube Clip
 - 1 Self Tapping Screw for Siphoning Tube Clip
 - Spray Gun
 - Nozzle Extension with Adjustable Nozzle
 - Oil Bottle
 - O-Ring Maintenance Kit

If any of the above parts are missing or damaged, call the pressure washer helpline at **1-800-270-1408**.

Preparing Pressure Washer for Use

If you have any problems with the assembly of your pressure washer or if parts are missing or damaged, call the pressure washer helpline at **1-800-270-1408**.

To prepare your pressure washer for operation, you will need to perform these tasks:

- Remove shipping cap on top of pump.
- Attach the handle and attach the wire form that holds the high pressure hose and spray gun.
- Connect the high pressure hose to the spray gun and the pump.
- Connect the water supply to the pump.
- Add oil to the engine crankcase.
- Add fuel to the fuel tank.

Remove Shipping Cap

To prevent oil from leaking from the pump, a shipping cap has been installed on the oil breather of the pump. You must remove the cap for your pressure washer to operate properly (Figure 1).

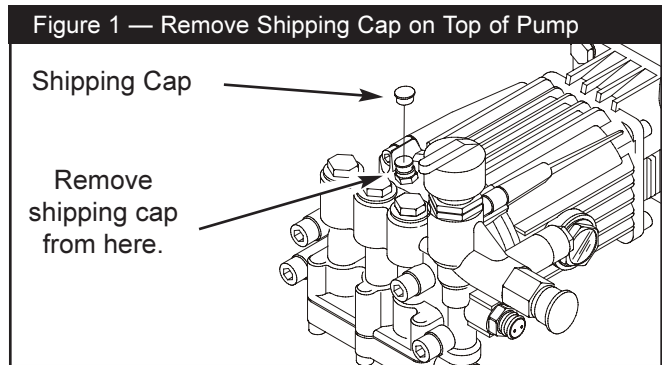

CAUTION! Running unit with the shipping cap installed will damage the pump and void your warranty.

Attach Handle and Wireform

- Place the handle onto the handle supports already connected to the main unit. Make sure the holes in the handle align with the holes on the handle supports. (Figure 2)

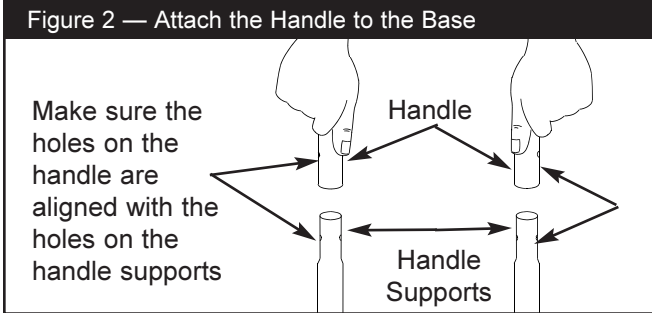
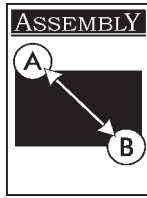

NOTE: It may be necessary to move the handle supports from side to side in order to align the handle so it will slide over the handle supports.

- Insert the carriage bolts through the holes on the handle and attach the plastic knobs. Tighten the knobs by hand (Figure 3).

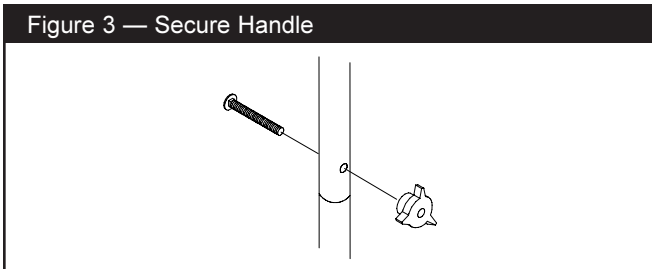

- Attach siphoning tube clip onto the right side of the handle (from the rear of the unit), with the self tapper just underneath the billboard.
- Insert the detergent siphoning tube into the clip on the handle (Figure 4).

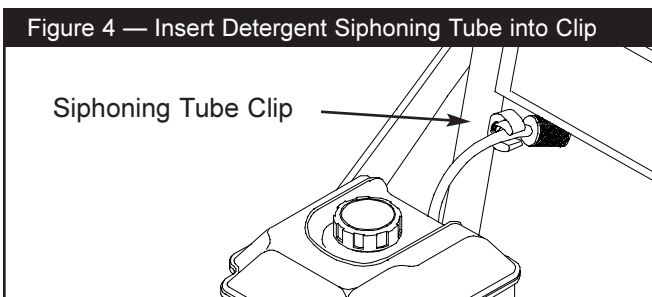

- Insert the wire support with the longer arm positioned on the left. From this view (from rear of unit), the hook should resemble a “J” (Figure 5).

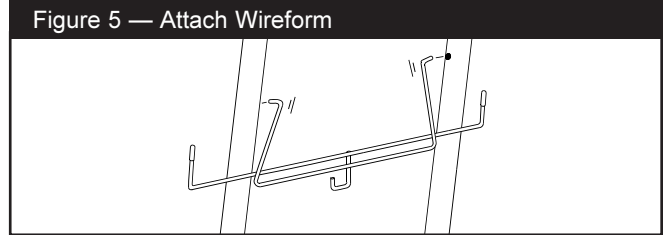

Add Engine Oil

IMPORTANT: Any attempt to crank or start the engine before it has been properly serviced with the recommended oil may result in an engine failure.

- Place pressure washer on a level surface.
- Refer to engine owners manual to add recommended oil to engine.

NOTE: Check Oil Often During Engine Break-in.

NOTE: The pump is pre-lubricated and sealed, requiring no additional lubrication for the life of the pump.

Add Gasoline

DANGER! Never fill fuel tank indoors. Never fill fuel tank when engine is running or hot. Do Not smoke when filling fuel tank.

WARNING! Never fill fuel tank completely full. Wipe away any fuel spillage from engine and equipment before starting.

- Use clean regular unleaded fuel and store in approved clean covered containers. Use clean fill funnels. **Never** use “stale” gasoline left over from last season or gasoline stored for long periods.
- Clean the area around the fuel fill cap, remove the cap. Slowly fill tank to about 1/2” below the bottom of the filler neck (Figure 6).

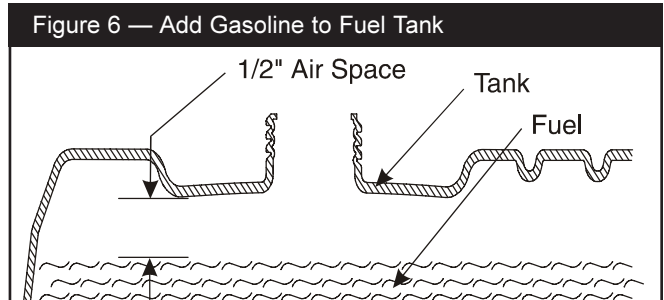

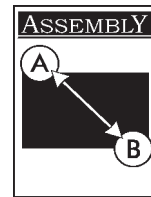

- Install the fuel cap and wipe up any spilled gasoline.

Connect Hose and Water Supply to Pump

IMPORTANT: You must assemble the nozzle extension to the spray gun and attach all hoses before you start the engine. Starting engine without all hoses connected and water supplied will damage the pump.

- Uncoil high pressure hose and attach quick connect end of hose to the base of the spray gun (Figure 7). Pull down on the collar of the quick connect, slide onto the gun and let go of collar. Tug on hose to be sure of a tight connection.

Figure 7 — Connect High Pressure Hose to Spray Gun

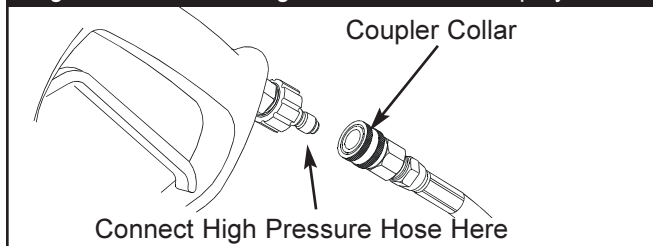

- Attach the other end of the high pressure hose to the high pressure outlet on the pump (Figure 8). Pull down on the collar of the quick connect, slide onto the pump and let go of collar. Pull on hose to be sure of a tight connection.

Figure 8 — Connect High Pressure Hose to Pump

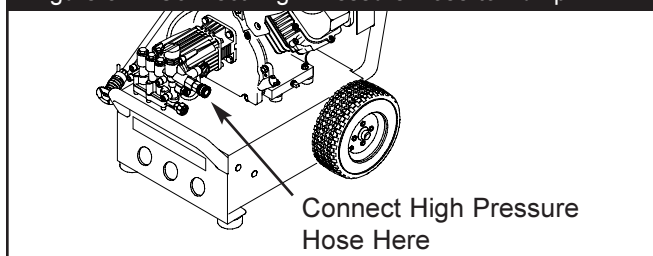

- Before you connect your garden hose to the water inlet, inspect the inlet screen (Figure 9). Clean the screen if it contains debris, replace if it's damaged. **DO NOT RUN THE PRESSURE WASHER IF THE SCREEN IS DAMAGED.**
- Run water through your garden hose for 30 seconds to clean out any debris. Turn off water.
- Connect the garden hose to the water inlet. Tighten by hand (Figure 9).

Figure 9 — Connect Garden Hose to Water Inlet

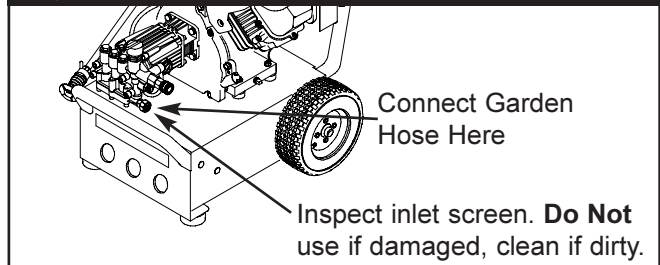

WARNING! There MUST be at least ten feet of unrestricted garden hose between the pressure washer inlet and any flow shut off device, such as a 'Y' shut-off connector or other convenience-type water shut-off valve. Damage to pressure washer resulting from disregarding this warning will not be covered by the warranty.

- Turn ON the water and open valve all the way. The water supply should be minimum 3.2 gallons per minute.
- Squeeze the trigger on the spray gun until you have a steady stream of water. This purges the pump of air and impurities.

CAUTION! Before starting the pressure washer, be sure you are wearing adequate eye protection.

- Attach the adjustable nozzle extension to the spray gun. Tighten by hand (Figure 10).

Figure 10 — Connect Nozzle Extension to Spray Gun

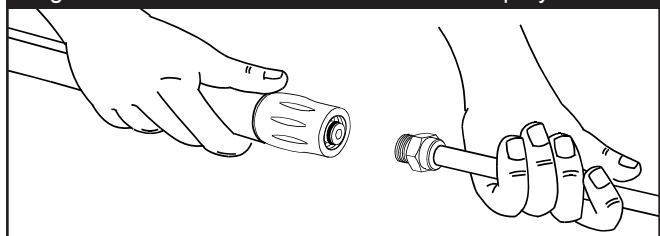

Checklist Before Starting Engine

Review the unit's assembly to confirm you have performed all of the following:

- Make sure the handle and wireform are in place and secure.
- Check for properly tightened hose connections.

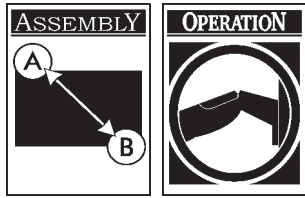

- Check to make sure that there are no kinks, cuts, or damage to the high pressure hose.
- Check that oil has been added to the proper level in the engine crankcase.
- Add the proper gasoline to fuel tank.
- Provide a proper water supply (not to exceed 140°F) at an adequate flow.
- Be sure to read the “Safety Rules” (page 2) and “Preparing Pressure Washer For Use” (page 5) before using the pressure washer.

HOW TO USE YOUR PRESSURE WASHER

If you have any problems operating your pressure washer, please call the pressure washer helpline at **1-800-270-1408**.

How to Start Your Engine

The best way to start your engine-powered pressure washer for the first time is to follow these instructions step-by-step. You may also refer to your engine owner’s manual. This starting information also applies whenever you start the engine after you have let the pressure washer sit idle for at least a day.

- Place the pressure washer in an area close enough to an outside water source capable of supplying water at a flow rate greater than 3.2 gallons per minute.
- Check that the high pressure hose is tightly connected to the spray gun and to the pump. See “Preparing Pressure Washer for Use” (page 5) for illustrations.
- Make sure unit is in a level position.
- Connect the garden hose to the water inlet on the pressure washer pump. **Turn ON the water.**

 **CAUTION!** Do Not run the pump without the water supply connected and turned on. You must follow this caution or the pump will be damaged.

- Squeeze the trigger on the spray gun until you have a steady stream of water. This purges the pump of air and impurities.

- Attach the adjustable nozzle extension to the spray gun. Tighten by hand.
- Position the nozzle in the low pressure mode (see “How to Use the Adjustable Nozzle”) and squeeze the trigger on the spray gun to relieve the air pressure caused by turning ON the water. Water will flow out of the spray gun in a thin stream. Continue to hold trigger until there is a steady stream of water and no air remains in the system. This will make it easier to pull start the engine. Release the trigger.

Figure 11 — Spray Gun with Safety Latch Engaged

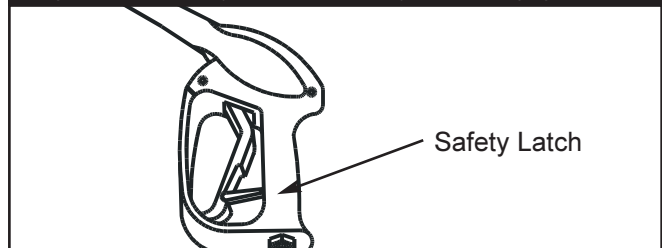

- Engage the safety latch to the spray gun trigger (Figure 11).
 - Position the choke to the “Full” choke position.
- NOTE:** For a warm engine, be sure the choke lever is in the “No” choke position.
- Move throttle lever to “Fast” position.
 - Grasp the starter grip handle and pull slowly until you feel some resistance. Then pull rapidly to start the engine.
 - Return the starter grip handle slowly. **Do Not** let rope “snap back” against starter.
 - If the choke was placed in the “Full” choke position to start the engine, slowly push it to the “No” choke position as soon as the engine warms up enough to run smoothly.
 - If the engine fails to start, review instructions given in the engine owner’s manual.

How to Stop Your Pressure Washer

- Move throttle lever to “Stop” position.
- **Squeeze trigger on the spray gun to relieve pressure in the hose.**

NOTE: A small amount of water will squirt out when you release the pressure.



How to Use the Adjustable Nozzle

You now should know how to **START** your pressure washer and how to **STOP** it. The information in this section will tell you how to adjust the spray pattern and to apply detergent or other cleaning chemicals.

! DANGER! Never adjust spray pattern when spraying. Never put hands in front of nozzle to adjust spray pattern.

- Slide the nozzle forward when you wish to adjust the spray to low pressure mode (Figure 12). Slide the nozzle backward to achieve high pressure.

Figure 12 — Adjusting Nozzle for Pressure

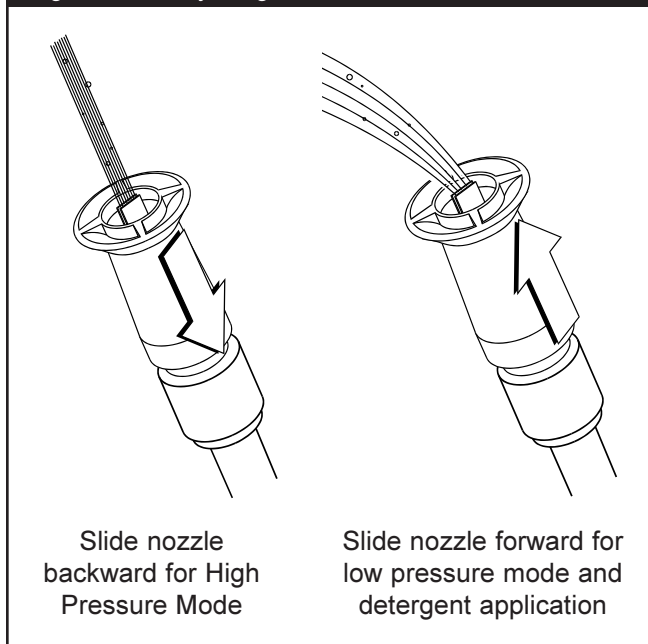

- Point the nozzle down towards a firm surface and press the trigger to test the pattern (Figure 13).
- Twisting the nozzle adjusts the spray pattern from a narrow pattern to a fan pattern (Figure 14).
- For most effective cleaning, keep spray nozzle between 8 to 24 inches away from cleaning surface.
- If you get the spray nozzle too close, especially using high pressure mode, you may damage the surface being cleaned.
- **Do Not** get closer than 8 inches when cleaning tires.

Figure 13 — Testing the Spray Pattern

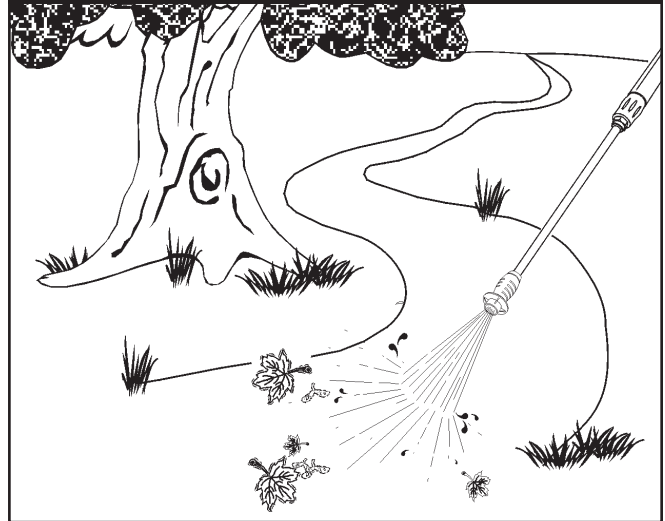
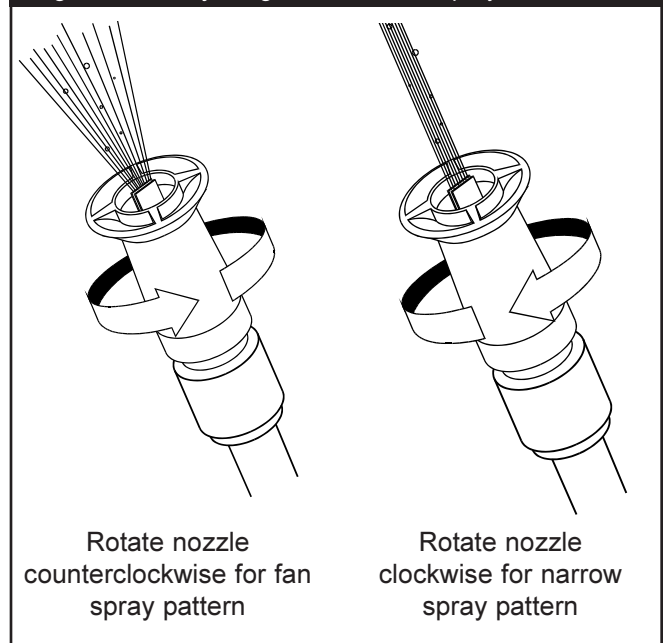

Figure 14 — Adjusting the Nozzle for Spray Pattern





Applying Detergent with the Adjustable Nozzle

IMPORTANT: Use soaps designed specifically for pressure washers. Household detergents could damage the pump.

IMPORTANT: You must **attach all hoses** before you start the engine. Starting the engine without all the hoses connected and without the water turned ON will damage the pump.

To apply detergent, follow these steps:

- Review the use of adjustable nozzles.
- Prepare the detergent solution as required by the job.
- Hang the detergent solution on the hook of the wireform attached to the handle, as shown in Figure 15.

Figure 15 — Insert Filter into Container



- Remove the detergent siphoning tube from the clip on the handle.
- Place the filter end of the detergent siphoning tube into the detergent container.

CAUTION! Keep the detergent siphoning tube from coming in contact with the hot muffler. This will damage the plastic tube. When inserting the filter into a cleaning solution bottle, route the tube so as to keep it from inadvertently contacting the hot muffler.

- Slide the adjustable nozzle forward to low pressure mode. Detergent cannot be applied with the nozzle in high pressure position.
- Make sure the garden hose is connected to the water inlet. Check that the high pressure hose is connected to the spray gun and the pump (see “Connect Hose and Water Supply to Pump”, page 7). Start the engine.

- Apply detergent to a dry surface, starting from the bottom and working up.
- Allow the detergent to “soak in” for 3-5 minutes before washing and rinsing. Reapply as needed to prevent surface from drying.
- For washing, start at lower portion of area to be washed and work upward, using long, even, overlapping strokes.

Pressure Washer Rinsing

WARNING! Be extremely careful if you must use the pressure washer from a ladder, scaffolding or any other relatively unstable location. Pressure in a running washer builds as you climb. When you press the trigger, the recoil from the initial spray could cause you to fall. The high pressure spray could also cause you to fall if you are too close to the cleaning surface.

For Rinsing:

- Slide the nozzle backward to high pressure, press the trigger and wait for the detergent to clear.
- NOTE:** You can also stop detergent from flowing by simply removing detergent siphoning tube from bottle.
- Keep the spray gun a safe distance from the area you plan to spray.
 - Apply a high pressure spray to a small area, then check the surface for damage. If no damage is found, it is okay to continue cleaning.
 - Start at the top of the area to be rinsed, working down with same overlapping strokes as you used for washing and applying detergent.

Automatic Cool Down System (Thermal Relief)

If you run the engine on your pressure washer for 3-5 minutes without pressing the trigger on the spray gun, circulating water in the pump can reach a temperature between 140–145°F. When the water reaches this temperature, the automatic cool down system engages and cools the pump by **discharging the warm water onto the ground**. This system prevents internal damage to the pump.

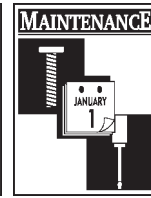

SPECIFICATIONS

Outlet Pressure	2300 psi
Flow Rate	2.9 gallons per minute (gpm)
Detergent	Use detergent approved for pressure washers
Water Supply Temperature	Not to Exceed 140°F
Automatic Cool Down System	Will cycle when water reaches 140°-145°F

GENERAL MAINTENANCE RECOMMENDATIONS

The pressure washer warranty does not cover items that have been subjected to operator abuse or negligence. To receive full value from the warranty, the operator must maintain the high pressure washer as instructed in this manual.

- Some adjustments will need to be made periodically to properly maintain your high pressure washer.
- All maintenance in this manual and the engine owner's manual should be made at least once each season.
- Once a year you should clean or replace the spark plug, clean or replace the air filter and check the spray gun and adjustable nozzle extension assembly for wear. A new spark plug and clean air filter assure proper fuel-air mixture and help your engine run better and last longer. Please refer to your engine owner's manual for more details.

BEFORE EACH USE

- Check engine oil level.
- Check water inlet screen for damage.
- Check in-line filter for damage.
- Check high pressure hose for leaks.
- Check detergent siphoning tube and filter for damage.
- Check spray gun and adjustable nozzle extension assembly for leaks.
- Rinse out garden hose to flush out debris.

PRESSURE WASHER MAINTENANCE

Check and Clean Inlet Screen

Examine the screen on the water inlet. Clean it if the screen is clogged or replace it if screen is damaged.

Check High Pressure Hose

The high pressure hose can develop leaks from wear, kinking, or abuse. Inspect the hose each time before using it. Check for cuts, leaks, abrasions or bulging of cover, damage or movement of couplings. If any of these conditions exist, replace the hose immediately.



WARNING! Water spraying from a leak is capable of injecting material into skin. Inspect hose each time before using it. **Never** repair a high pressure hose. Replace it with another hose that exceeds the maximum pressure rating of your pressure washer.

Check Detergent Siphoning Tube

Examine the filter on the detergent tube and clean if clogged. The tube should fit tightly on the barbed fitting. Examine the tube for leaks or tears. Replace the filter or tube if either is damaged.

Check Gun and Adjustable Nozzle Extension

Examine the hose connection to the spray gun and make sure it is secure. Test the trigger by pressing it and making sure it "springs back" into place when you release it. Put the safety latch in the **ON** position and test the trigger. You should not be able to press the trigger.

Purge Pump of Air and Contaminants

To remove air from the pump, follow these steps:

- Set up the pressure washer as described in "Preparing Pressure Washer For Use" (page 5). Connect the water supply and turn water on.
- Pull the trigger on the spray gun and hold.

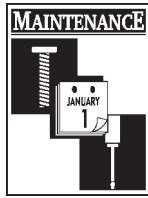

- When the water supply is steady and constant, engage the safety latch.

To remove contaminants from the pump, follow these steps:

- Set up the pressure washer as described in “Preparing Pressure Washer For Use” (page 5). Connect the water supply and turn water on.
- Remove the nozzle extension from the spray gun.
- Start the engine according to instructions in “How To Use Your Pressure Washer” (page 8).
- Squeeze the trigger on the spray gun and hold.
- When the water supply is steady and constant, engage the safety latch and refasten the nozzle extension.

Check In-Line Filter

Refer to Figure 16 and service the in-line filter if it becomes clogged, as follows:

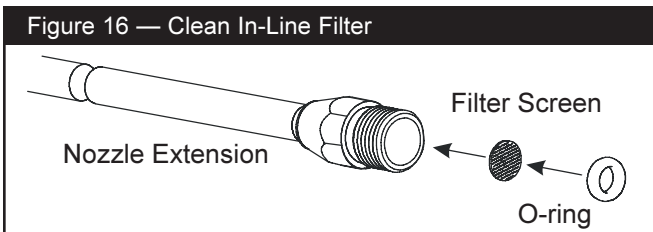

1. Detach spray gun and nozzle extension from high pressure hose. Detach nozzle extension from spray gun and remove o-ring and screen from nozzle extension. Flush the screen, spray gun, and adjustable nozzle extension with clean water to clear debris.
2. If the screen is damaged, the o-ring kit contains a replacement in-line filter screen and an o-ring. If undamaged, reuse screen.
3. Place the in-line filter screen into the threaded end of the nozzle extension. Direction does not matter. Push the screen in with the eraser end of a pencil until it rests flat at the bottom of the opening. Take care to not bend the screen.
4. Place the o-ring into the recess. Push the o-ring snugly against the in-line filter screen.
5. Assemble the nozzle extension to the spray gun, as described earlier in this manual.

Cleaning Detergent Siphoning Tube

If you used the detergent siphoning tube, you must flush it with clean water before stopping the engine.

- Place the detergent siphoning tube in a bucket full of clean water.
- Slide the adjustable nozzle forward to the low pressure position. Flush for 1-2 minutes.
- Shut off the engine.
- Insert detergent siphoning tube into clip on handle.

IMPORTANT: Simply shutting OFF engine will not release pressure in the system. **When the engine has shut down, squeeze the trigger on the spray gun to relieve the pressure in the hose.**

Nozzle Maintenance

If the adjustable nozzle becomes restricted or clogged with foreign materials such as dirt, excessive pump pressure may develop. A partially clogged nozzle causes a pulsing sensation during use.

If the adjustable nozzle becomes clogged or partially restricted, immediately clean the nozzle with the kit included with your pressure washer by following these instructions:

- Shut off the engine and turn off the water supply.
- Separate the nozzle extension from the spray gun.
- Adjust the nozzle extension to the stream position.
- Remove the nozzle from the end of the nozzle extension (Figure 17) using a 2mm or 5/64 allen wrench (like the one included in the kit).

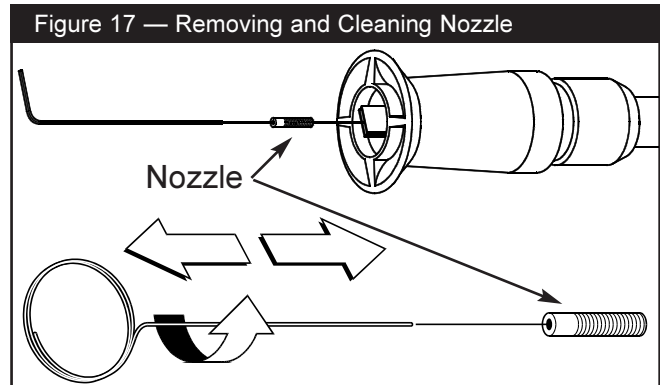

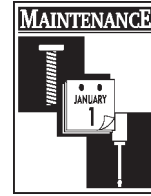

- Use the wire included in the kit (Figure 17) or a small paper clip to free the foreign material clogging or restricting the nozzle.
- Remove additional debris by back flushing water through the nozzle extension (Figure 18). Back flush between 30 to 60 seconds. Turn the nozzle extension to stream spray and move the nozzle from low to high while flushing.

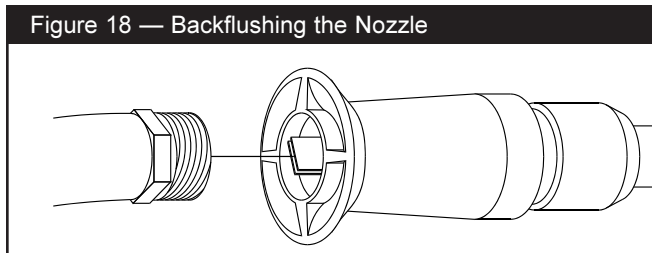

- Reinstall the nozzle into the nozzle extension. **Do Not** overtighten.
- Reconnect the nozzle extension to the spray gun.
- Reconnect the water supply, turn on the water, and start the engine.
- Test the pressure washer by operating with nozzle in the high and in the low positions.

O-Ring Maintenance

Through the normal operation of your pressure washer, o-rings are used to keep the connections of the hoses and spray gun tight and leak-free. These o-rings may become worn or damaged.

Provided with your pressure washer is an O-Ring Maintenance Kit which includes replacement o-rings, rubber washer and water inlet filter. Refer to the instruction sheet provided in the kit to service your unit's o-rings. Note that you will not use all of the parts in the kit.

To remove a worn or damaged o-ring:

- Use a small flathead screwdriver to get underneath the o-ring and pry it off.

ENGINE MAINTENANCE

See the engine owner's manual for instructions on how to properly maintain the engine.

PREPARING THE UNIT FOR STORAGE

Water should not remain in the unit for long periods of time. Sediments or minerals can deposit on pump parts and "freeze" pump action. If you do not plan to use the pressure washer for more than 30 days, follow this procedure:

1. Flush detergent siphoning tube by placing the filter into a pail of clean water while running pressure washer in low pressure mode (adjustable nozzle in the forward position). Flush for one to two minutes.
2. Shut off the engine and let it cool, then remove all hoses. Disconnect spark plug wire from spark plug.
3. Empty the pump of all pumped liquids by pulling the recoil handle about 6 times. This should remove most of the liquid in the pump. Insert detergent siphoning tube into clip on handle.

NOTE: To protect the unit from freezing temperatures, draw RV antifreeze (non-alcohol) into the pump by pouring the solution into a 3-foot section of garden hose connected to inlet adapter and pulling recoil handle twice.

4. Store unit in a clean, dry area.

Storing the Engine

See the engine owner's manual for instructions on how to properly prepare the engine for storage.



TROUBLESHOOTING

Problem	Cause	Correction
Pump has following problems: failure to produce pressure, erratic pressure, chattering, loss of pressure, low water volume.	<ol style="list-style-type: none"> 1. Nozzle in low pressure mode. 2. Water inlet is blocked. 3. Inadequate water supply. 4. Inlet hose is kinked or leaking. 5. Clogged inlet hose strainer. 6. Water supply is over 140°F. 7. High pressure hose is blocked or leaks. 8. Gun leaks. 9. Nozzle is obstructed. 10. Pump is faulty. 	<ol style="list-style-type: none"> 1. Pull nozzle backward for high pressure mode. 2. Clear inlet. 3. Provide adequate water flow. 4. Straighten inlet hose, patch leak. 5. Check and clean inlet hose strainer. 6. Provide cooler water supply. 7. Clear blocks in outlet hose. 8. Replace gun. 9. Clean nozzle. 10. Contact Generac service facility.
Detergent fails to mix with spray.	<ol style="list-style-type: none"> 1. Detergent siphoning tube is not submerged. 2. Chemical filter is clogged. 3. Nozzle is in high pressure mode. 	<ol style="list-style-type: none"> 1. Insert detergent siphoning tube into detergent. 2. Clean or replace filter/detergent siphoning tube. 3. Push nozzle forward for low pressure mode.
Engine runs good at no-load but “bogs” when load is added.	Engine speed is too slow.	Move throttle control to FAST position. If engine still “bogs down”, contact Briggs and Stratton service facility.
Engine will not start; or starts and runs rough.	<ol style="list-style-type: none"> 1. Low oil level. 2. Dirty air cleaner. 3. Out of gasoline. 4. Stale gasoline. 5. Spark plug wire not connected to spark plug. 6. Bad spark plug. 7. Water in gasoline. 8. Overchoking. 9. Excessively rich fuel mixture. 10. Intake valve stuck open or closed. 11. Engine has lost compression. 	<ol style="list-style-type: none"> 1. Fill crankcase to proper level. 2. Clean or replace air cleaner. 3. Fill fuel tank. 4. Drain gas tank; fill with fresh fuel. 5. Connect wire to spark plug. 6. Replace spark plug. 7. Drain gas tank; fill with fresh fuel. 8. Open choke fully and crank engine. 9. Contact Briggs and Stratton service facility. 10. Contact Briggs and Stratton service facility. 11. Contact Briggs and Stratton service facility.
Engine shuts down during operation.	<ol style="list-style-type: none"> 1. Out of gasoline. 2. Low oil level. 	<ol style="list-style-type: none"> 1. Fill fuel tank. 2. Fill crankcase to proper level.
Engine lacks power.	Dirty air filter.	Replace air filter.
Engine “hunts” or falters.	Choke is opened too soon.	Move choke to halfway position until engine runs smoothly.

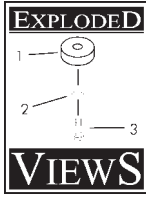

EXPLODED VIEW — UNIT

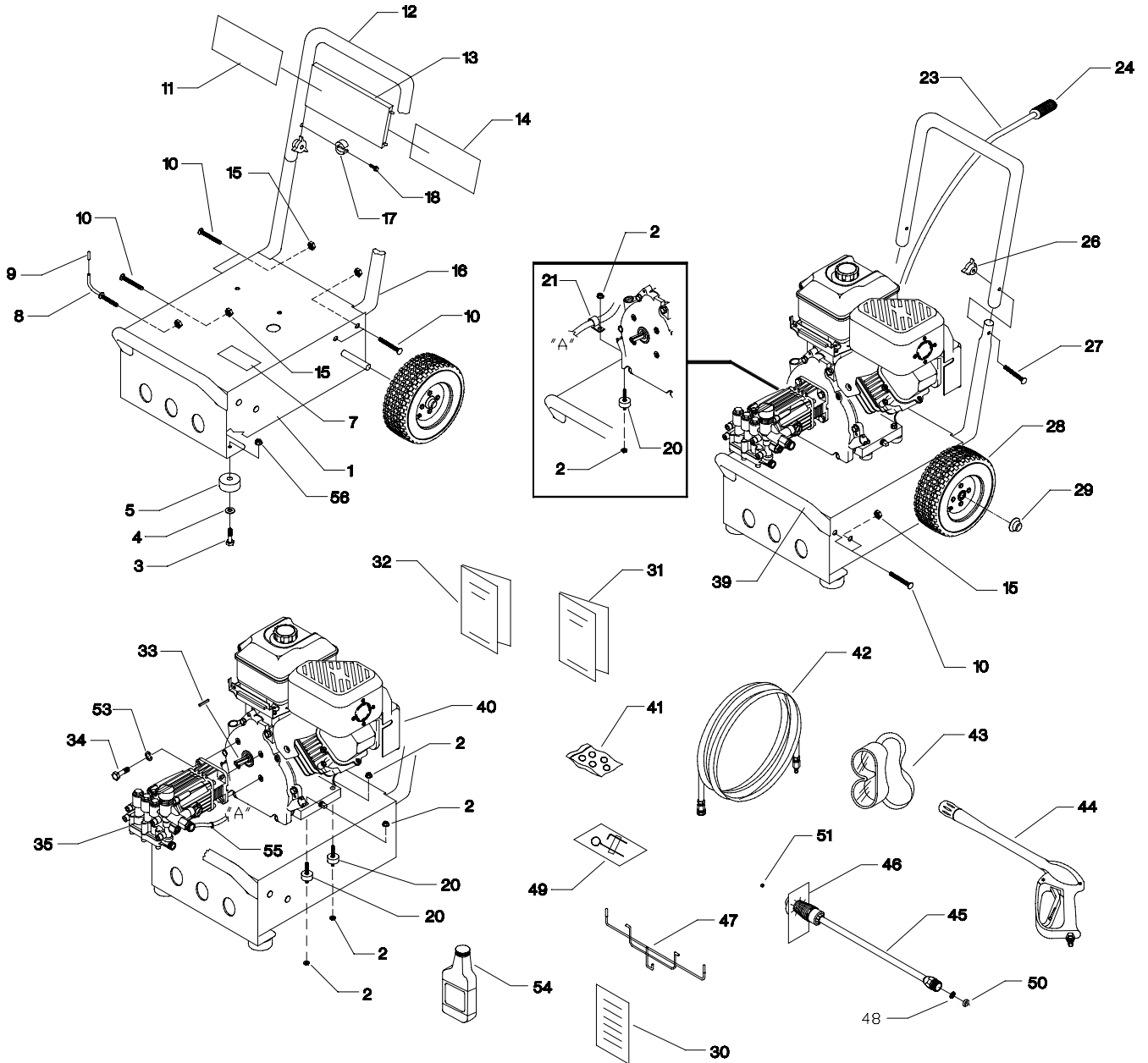

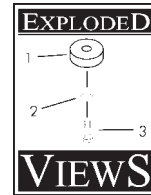

PARTS LIST — UNIT

Item	Part #	Qty.	Description	Item	Part #	Qty.	Description
1	AB5721	1	BASE	29	75402C	2	PUSHNUT, 5/8" Dia.
2	52858	8	LOCKNUT, M8	30	B4095	1	SHEET, Info
3	42909	2	HHCS, M8 1.25 x 30	31	NSP	1	MANUAL, Engine
4	50190	2	WASHER, Flat .34" x 1"	32	B5715	1	MANUAL
5	27007	2	MOUNT, Donut Type Vibration	33	23139B	1	KEY, 3/16" sq. x 1-1/2"
7	B4099	1	DECAL, IMP. Purge Air	34	95531	4	SHCS, 5/16" - 24 x 3/4"
8	B2150	1	HOOK, Gun	35	187264	1	ASSEMBLY, Complete Pump (see pages 18-21)
9	B2516	1	CAP, Vinyl (black)				
10	B2043	7	BOLT, 5/16"-18 x 1-3/4" Carriage	39	B1982	1	BUMPER
11	B5713	1	DECAL, Logo	40	NSP	1	ENGINE
12	B1983	1	HANDLE	41	B5830	1	KIT, "O" Ring
13	B1631A	1	BILLBOARD, Plastic	42	B5694	1	HOSE, High Pressure
14	B1932	1	DECAL, Instructions	43	87815	1	GOGGLES, Safety
15	99583	8	NUT, Flange Lock 5/16"-18	44	B3263A	1	GUN, High Pressure
16	B1981	2	SUPPORT, Handle	45	B3335C	1	LANCE, Nozzle Hi/Lo
17	65852A	1	SPRING CLIP, Holder	46	97566	1	TAG, Nozzle Instructions
18	185954	1	SCREW, Self Tap #8 - 18 x 1/2"	47	B2168A	1	HANGER, Hose, Gun, Jug
20	21217	4	MOUNT, Rubber Shock	48	B4224	1	SCREEN, Gun Inlet
21	B1232	1	CLAMP, Hose 7/16" Dia.	49	B2163	1	KIT, Nozzle Cleaning
23	A1040D	1	HOSE, 4-1/2' Chemical Clear	50	97837	1	O-RING, Hi Pressure
24	A1041	1	FILTER, Chemical Hose	51	92661	1	NOZZLE, 1.20 Blue Replacement
26	97178	2	KNOB, Handle 1/4" - 20 PW	53	92479	4	LOCKWASHER, Ribbed
27	31669	2	BOLT, 1/4" - 20 x 1-3/4" Carriage	54	BB3061B	1	OIL
28	B4966	2	ASSEMBLY, 10" Tire & Wheel	55	48031G	1	CLAMP, Hose
				56	52858	2	NUT, Locking M8 - 1.25

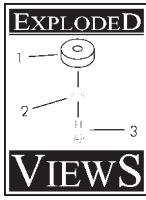

EXPLODED VIEW — PUMP

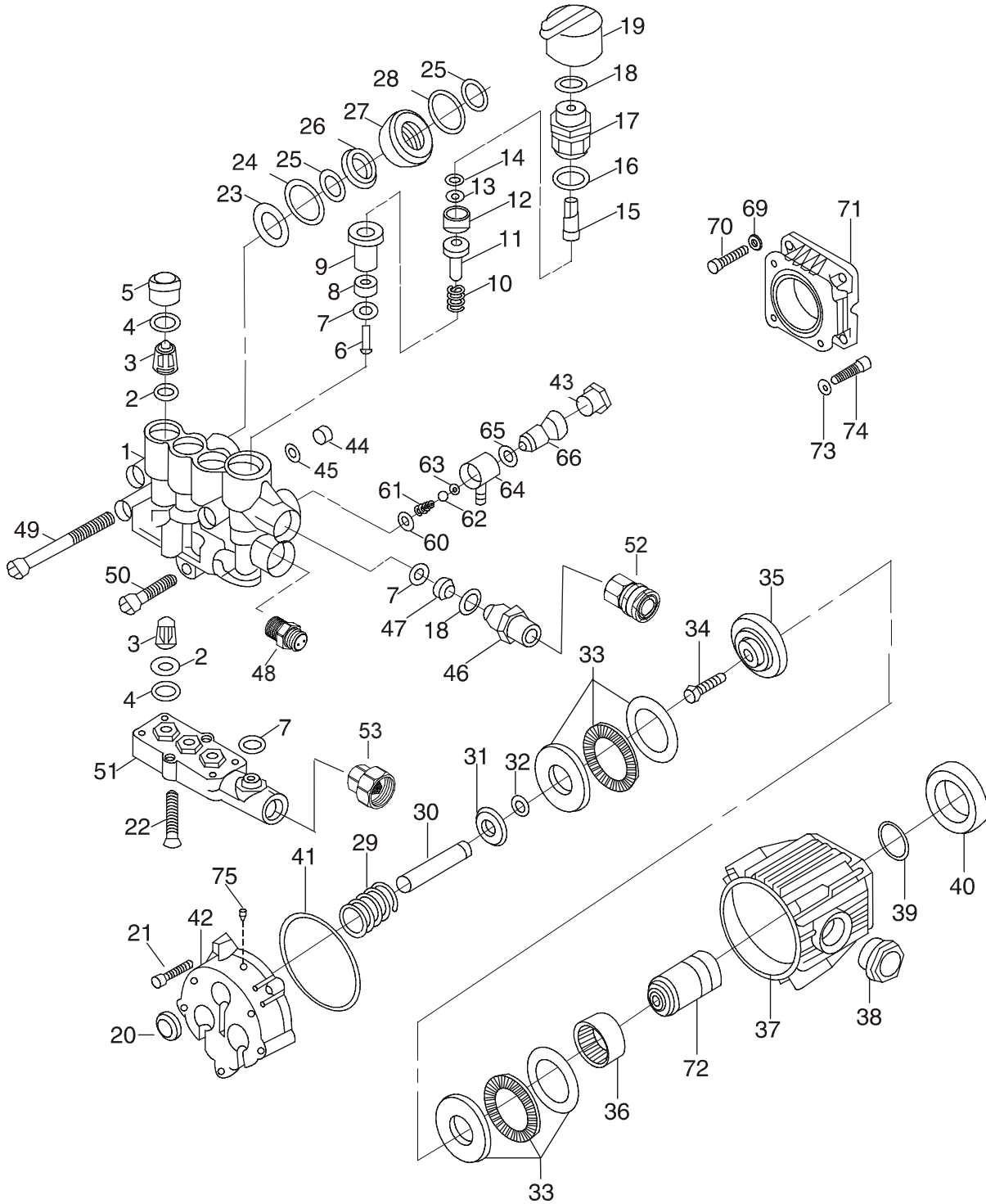

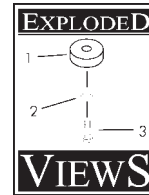

PARTS LIST — PUMP

Item	Part #	Qty	Description	Item	Part #	Qty	Description
0	187264	0	Complete Pump Assy.	34	148B3169	1	Screw, M8 x 28
1	100B3699	1	Manifold	35	134B3699	1	Wobble plate
2	165B3169	6	O-ring 12.42 x 1.78	36	135B3699	1	Bearing bushing
3	102B3699	6	Valve unit	37	136B3699	1	Crankcase
4	103B3699	6	O-ring 5.60 x 1.78	38	100B3699A	1	Cap, Brass
5	104B3699	3	Valve cap	39	138B3699	1	Snap ring
6	105B3699	1	Unloader valve screw	40	139B3699	1	Oil seal
7	106B3699	3	O-ring 9.92 x 2.62	41	12092293P	1	O-ring
8	107B3699	1	Valve seat	42	141B3699	1	Piston guide
9	108B3699	1	Spacer	43	142B3699	1	Plug, M14 x 1.5 x 9mm
10	119B3699	1	Spring	44	143B3699	1	Plug, 10mm
11	110B3699	1	Unloader piston	45	144B3699	1	O-ring
12	111B3699	1	Seal	46	100B3169A	1	Nipple, 3/8 NPT
13	112B3699	1	O-ring	47	146B3699	1	Orifice, 1.8mm
14	113B3699	1	Anti-extrusion ring	48	B3213	1	Thermal Relief Valve
15	114B3699	1	Unloader stem	49	148B3699	4	Screw, M8 x 70
16	10892293P	1	O-ring	50	149B3699	1	Screw, M8 x 25
17	116B3699	1	Guide	51	150B3699	1	Inlet manifold
18	10292293P	2	O-ring	52	95458	1	Quick Connect
19	118B3699	1	Regulating knob	53	89647A	1	Garden Hose Connector
20	119B3699	3	Oil seal	60	177B3169	1	O-ring
21	120B3699	4	Screw, M6 x 30	61	178B3169	1	Spring, conical
22	12692294P	6	Screw, M6 x 30	62	179B3169	1	Ball, 7/32"
23	122B3699	3	Head ring	63	11492293P	1	O-ring
24	123B3699	3	O-ring	64	197B3169	1	Hose barb
25	120B3169	6	O-ring	65	112B3169	1	O-ring
26	125B3699	3	Packing	66	157B3699	1	Injector housing
27	126B3699	3	Retainer 15mm	69	12492293P	4	Washer
28	119B3169	3	O-ring	70	159B3699	4	Screw
29	128B3699	3	Spring 33 x 56	71	160B3699	1	Gas mounting flange
30	129B3699	3	Piston assembly	72	161B3699	1	Crankshaft
31	130B3699	3	Spring plate	73	10692293P	4	Washer
32	131B3699	3	Spring plate retainer	74	12692293P	4	Screw
33	132B3699	2	Roller bearing	75	164B3699	1	Vent plug

Repair Kits

Description	Part #	Items included in kit	# Assys in Kit
High Pressure Seal	201B3699	23, 24, 25, 26, 27, 28	1
Check Valve C / O Ring	202B3699	4, 5	4
Check Valve / O Ring	203B3699	2, 3	6
Oil Seal	204B3699	20	3
Unloader	205B3699	6, 7, 8, 9, 10, 11, 12, 13, 14, 15, 16, 17, 18	1

LIMITED PRESSURE WASHER WARRANTY

GENERAC PORTABLE PRODUCTS (hereafter referred to as the COMPANY) warrants to the original retail purchaser, the pressure washer manufactured by the COMPANY to be free from defects in material and workmanship for the period(s) set forth below from the date of original purchase. This warranty is not transferable. The term "original purchaser" means the person for whom the pressure washer is originally purchased.

Warranty Schedules

Electric Power Washer	1 year (does not apply to commercial or rental applications)		
		CONSUMER*	COMMERCIAL*
All Other Engine-driven	Engine:	Warranted solely by Engine Manufacturer	Warranted solely by Engine Manufacturer
	Pump:	1 year	90 days

*** NOTE: For the purpose of this warranty "consumer" use means personal residential household use by original purchaser. "Commercial" use means all other uses, including rental, construction, commercial and income producing purposes. Once a pressure washer has experienced commercial use, it shall thereafter be considered a commercial use pressure washer for the purposes of this warranty.**

During said warranty period, the COMPANY will, at its option, repair or replace any part which, upon examination by the COMPANY or COMPANY-Authorized Dealers, is found to be defective under normal use and service**. All transportation costs under warranty, including return to the factory if necessary, are to be borne by the purchaser and prepaid by the purchaser.

**** NORMAL WEAR: As with all mechanical devices, pressure washers need periodic parts service and replacement to perform well. This warranty does not cover repair when normal use has exhausted the life of a part or pressure washer pump.**

This warranty does not include: Used products and demonstration equipment. Parts, such as GUNS, HOSES, WANDS, NOZZLES or other wear items such as quick couplers, oil, gauges, belts, o-rings, filters, pump packing, etc. Pumps which have been run without water supplied. Damage or malfunctions resulting from: accidents, abuse, modifications, alterations, or improper servicing. Freezing or chemical deterioration. Normal maintenance such as adjustments, fuel system cleaning and obstruction (due to chemical, dirt, carbon or lime, etc.).

THIS WARRANTY IS IN PLACE OF ALL OTHER WARRANTIES, EXPRESS OR IMPLIED, SPECIFICALLY, THE COMPANY MAKES NO OTHER WARRANTIES AS TO MERCHANTABILITY OR FITNESS FOR A PARTICULAR PURPOSE. THE DURATION OF ANY IMPLIED WARRANTIES WHICH CANNOT BE DISCLAIMED IS LIMITED TO THE TIME PERIOD AS SPECIFIED IN THE EXPRESS WARRANTY. LIABILITY FOR CONSEQUENTIAL, INCIDENTAL, OR SPECIAL DAMAGES UNDER ANY AND ALL WARRANTIES IS EXCLUDED, EVEN IF SUCH DAMAGES ARE A DIRECT RESULT OF THE COMPANY'S NEGLIGENCE. THE COMPANY ALSO DISCLAIMS ANY RESPONSIBILITY FOR INCIDENTAL OR CONSEQUENTIAL DAMAGES SUCH AS THE LOSS OF TIME OR THE USE OF THE POWER EQUIPMENT, OR ANY COMMERCIAL LOSS DUE TO THE FAILURE OF THE EQUIPMENT: AND ANY IMPLIED WARRANTIES ARE LIMITED TO THE DURATION OF THIS WRITTEN WARRANTY.

Some states do not allow limitations on how long an implied warranty lasts, or the exclusion or limitation of incidental or consequential damages, so the above limitations or exclusions may not apply to you. This warranty gives you specific legal rights and you may also have other rights, which vary from state to state.

For service, see your nearest COMPANY-Authorized warranty service facility or call 1-877-544-0982. Warranty service can be performed only by a COMPANY-Authorized service facility. This warranty will not apply to service at any other facility. At the time of requesting warranty service, evidence of original purchase date must be presented.

Generac Portable Products

Jefferson, Wisconsin U.S. A.